

Antares, Inc.

Engraving Tools Catalog

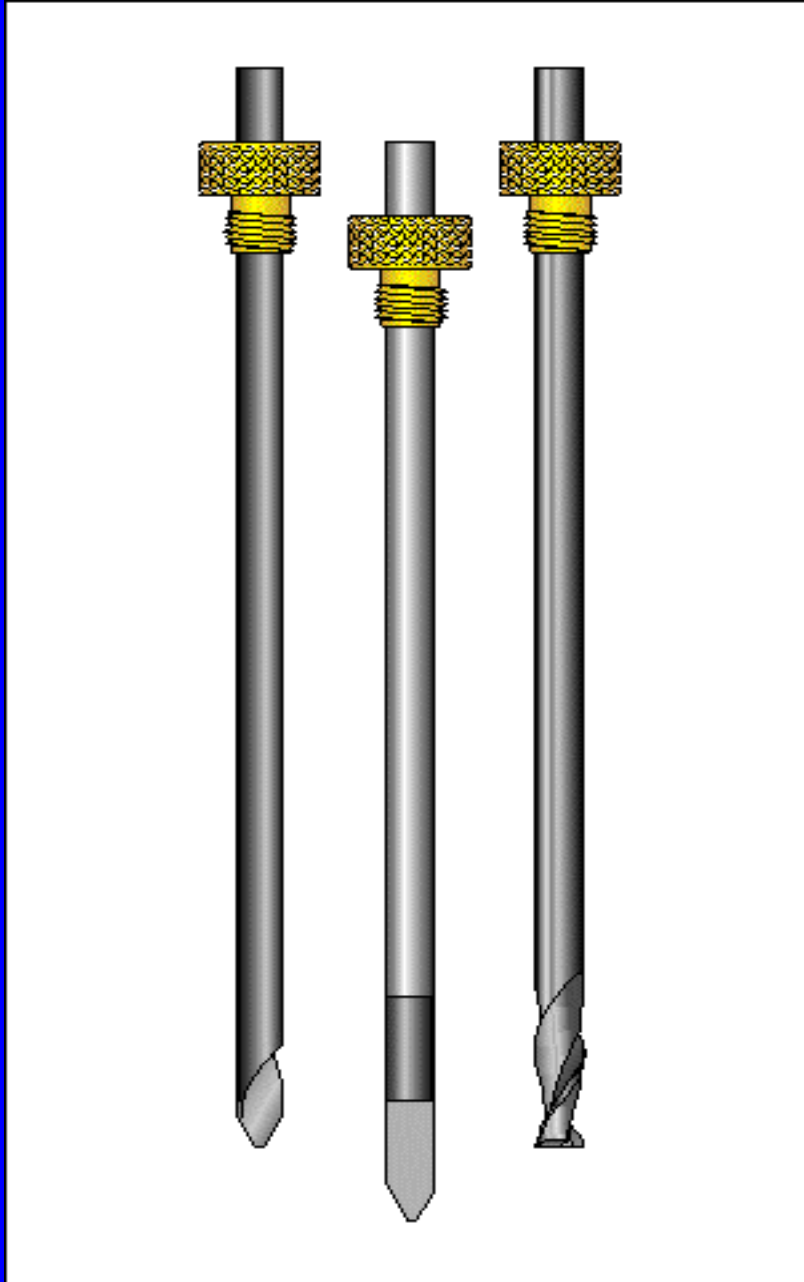

***Quality Cutting Tools and Resharpening Service
for the Engraving and Sign Making Industries***

Understanding Material Classifications

Antares cutters are manufactured in a variety of shank diameters and lengths for all types of materials and applications. To meet your engraving needs, we manufacture and sharpen our cutters to exacting specifications. It is very important to use the proper cutter for the material being engraved. Cutters sharpened for soft materials such as plastic will dull quickly if used to engrave harder materials. Conversely, cutters sharpened for metals will not produce optimum results in softer materials. For ordering purposes, please specify which materials you will be engraving or reference the following Standard Material Classifications:

- ACR:** Acrylic (Plexiglass®, Lexan® - *Specify if reverse engraving*)
- BAL:** Brass, Aluminum, Soft Metals
- FLX:** Flexible Engraving Stock (Rowmark®, Gravoply®, etc.)

- PHN:** Phenolic (Formica®, Fiberglass®)
- SSS:** Stainless Steel, Steel, Hard Metals

Standard Cutter Specifications

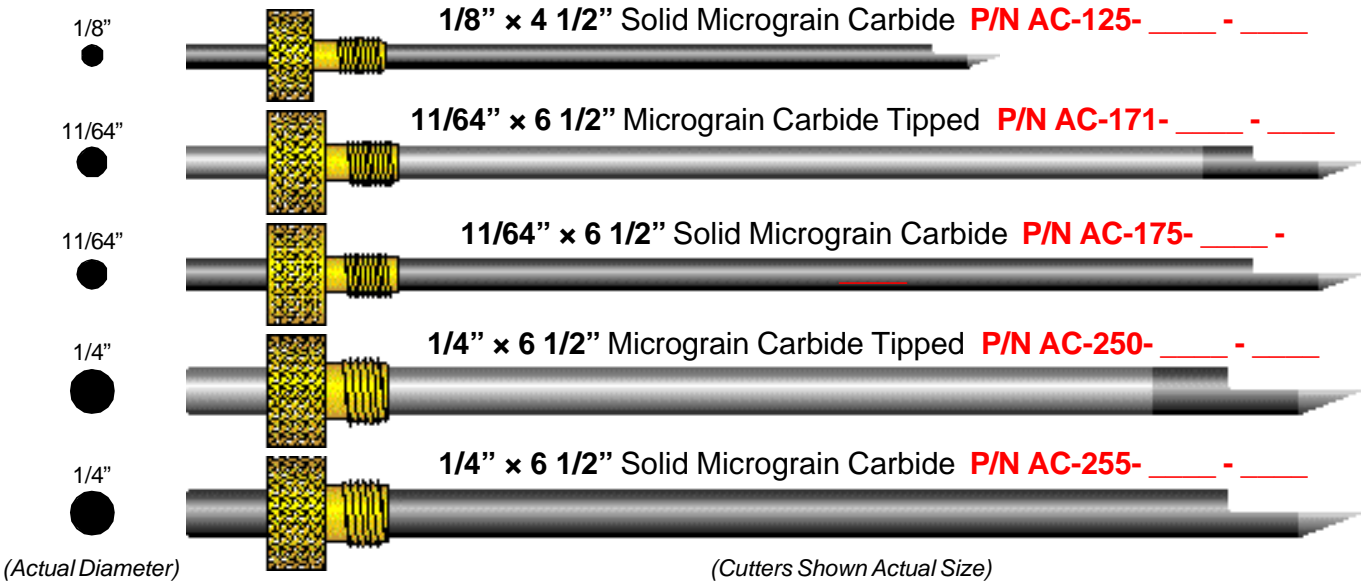

Selecting the Appropriate Tip Width

The chart below displays the most commonly used letter height/tip width combinations for single line fonts. When engraving single stroke characters, we recommend that the width of the cut be approximately 12% of the letter height to achieve proportional letters. For example: engraving a 1/2" (0.50") letter, the stroke should be .060"; (0.50" x 12% = .060"). Cutters and burnishers are available in any required tip size, in .005" increments, ranging from a point (.000") up to the full shank diameter. Maximum stroke width of a 1/8" cutter is .125". Maximum stroke width of a 11/64" cutter is .171". Maximum stroke width of a 1/4" cutter is .250". (Cuts wider than the shank diameter can only be made with the Wide-Cut tool. See page 6 for details.) Please specify tip width when ordering.

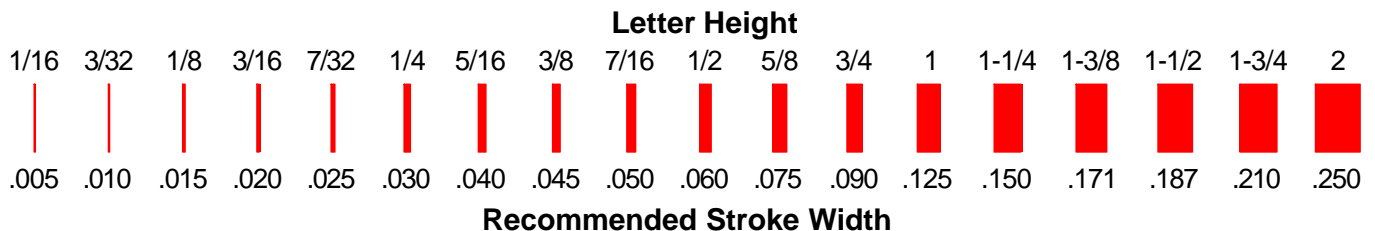

Standard Cutters

Our most frequently used tool for engraving plastics and metals. Antares cutters are made from Micrograin carbide with our exclusive MicroEdge® finish to produce cleaner cuts and stay sharper longer. Standard cutting tools produce a cut with a 30° side angle for plastics and a 40° side angle for metals. Standard cutters are available in a variety of tip widths ranging from a point (.005") to the full width of the shank, in .005" increments.

Pricing: Page 1/Row A

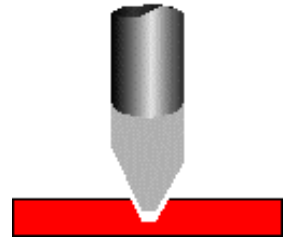

Quarter Round Cutters

A cutter with a second split, perpendicular to that of a standard half round tool, to provide greater chip clearance. Effective for many applications such as engraving stainless steel, acrylic, and soft materials that require greater clearance. Also work well for cutting out characters and shapes in soft material. Quarter Round cutters are available in a variety of tip widths ranging from a point (.000") to the full width of the shank, in .005" increments.

Pricing: Page 1/Row B



Burnishers

Burnishing is a surface marking technique used to expose the bare metal on coated materials, such as lacquered brass or aluminum. These tools are used in a rotating spindle without a depth nose. Burnishers are not meant to cut deeply into material. Best results are obtained by using very light spindle pressure and a burnishing attachment. Available in a variety of tip widths ranging from a point (.005") to the full width of the shank, in .005" increments. Also available with a diamond tip. See page 4.

Pricing: Page 1/Row C

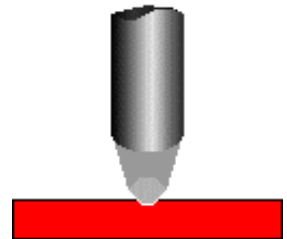

Profilers

A Profiling tool has a narrow cutting angle and is effective for fine detail engraving and cutting out shapes where a slight bevel is acceptable. The standard angle on a Profiler is 15°. Recommended for applications where smallest parallel tip available is too wide or too fragile. Standard tip widths range from .005" to .060". Larger tip sizes are available.

Pricing: Page 1/Row D

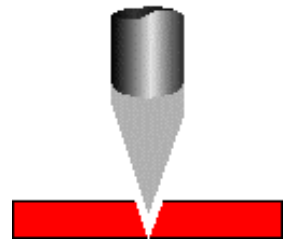

Parallel Cutters

A parallel tool will produce a cut with straight edges and a flat bottom, as opposed to the angled or "V" cut from a standard tool. The smallest recommended tip size is .060". We recommend that the depth of the cutter not exceed 150% of the width. Maximum depth is double the width. When ordering, be sure to specify the depth of the cut required, or material thickness if cutting completely through. Antares also offers Parallel cutters with a point for drilling holes. Add \$1.00 to regular parallel tool pricing for drill point.

Pricing: Page 1/Row E

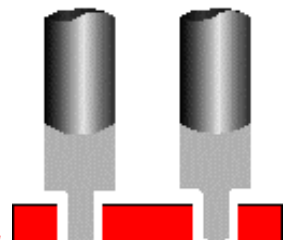

Cutter-Bevelers

Cuts out and bevels in one smooth operation. A Cutter-Beveler has a parallel cutting edge which profiles or cuts through the material. The angled edge produces a 45° bevel for a depth of 1/3 to 1/2 of the material thickness. This can be beneficial for applications such as cutting out badges (on an engraving machine) or producing discs or odd shaped items which are difficult or impossible to do with a beveling machine.

Pricing: Page 1/Row F

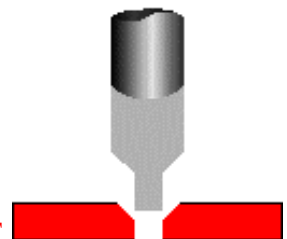

Ballnose Cutters

A cutter with a radiused tip that produces a cut with a rounded bottom instead of a flat bottom. Available as a parallel cutter (straight sides) or a conical cutter (angled sides). These cutters are extremely effective for reverse engraving in acrylic and for 3-Dimensional engraving applications. Parallel Ballnose cutters are available from .060" to the full shank diameter. Conical Ballnose cutters are available from .005" to half the shank diameter. *An Antares Fact Sheet is available on our web page: www.antaresinc.net.*

Pricing: Page 1/Row G

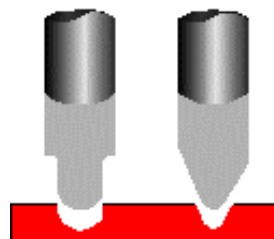

ADA Braille Dot Cutters

The Americans with Disabilities Act has placed strict regulatory standards on the sign industry. We offer tools for cutting Braille dots and for making Cut-Out Letters. (See below) The Braille Dot cutter is a tool that routs away the background material and leaves Braille dots with rounded tops. *An Antares Fact Sheet is available on our web page: www.antaresinc.net.*

Pricing: Page 1/Row H

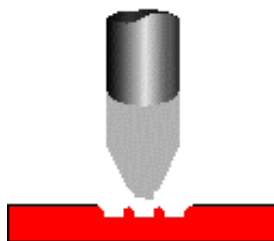

ADA Cut-Out Letter Cutter

The Cut-Out Letter tool is a quarter round tool with a 22° cutting angle used to create raised letters and numbers using plastic overlay materials in accordance with the Americans with Disabilities Act. *An Antares Fact Sheet is available on our web page: www.antaresinc.net.*

Pricing: Page 1/Row I

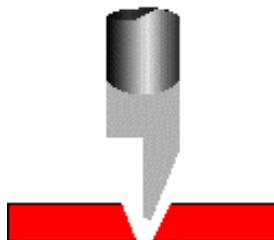

Dovetail Cutters

For making an angled undercut in plastics for applications such as directory boards with slide in legend strips. Produces a 15° bevel. For cutting out the legend strips, we recommend the use of a 15° Profiling cutter. *An Antares Fact Sheet is available on our web page: www.antaresinc.net.*

Pricing: Page 1/Row J

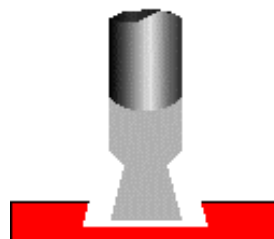

Wide-Cut Cutters

Cutters which cut wider than their shank diameter. Cutters with shank diameters of 1/8" and 11/64" can produce cuts up to .250" wide. 1/4" cutters can cut up to .500" wide. Wide-Cut tools are for engraving plastics only. They are loaded from the bottom of the spindle and are used with a reduced motor speed and feed rate.

Pricing: Page 1/Row K

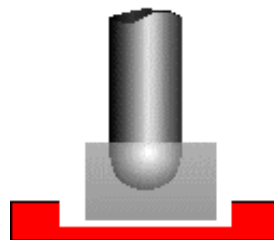

Bevel & Border Cutters

Beveling is the process of creating a sloped edge on a plate, most often through the use of a 30° or 45° cutter and a beveling machine. A cutter with a 45° cutting angle is the most popular choice because it creates a more pronounced cut by exposing more of the core material.

Pricing: Page 2/Row F

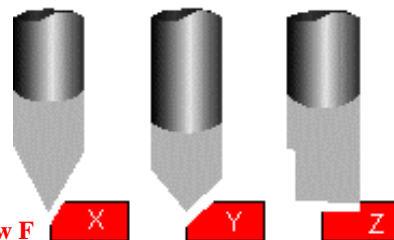

CleanCut Cutters®

CleanCut® cutters have been designed with an extra grind behind the cutting edge to increase the clearance without weakening the tool. The result is a tool that is as strong as a traditional half-round tool, yet has clearance similar to a quarter-round tool. These tools are effective for engraving softer materials that are difficult to cut with tools with standard angles. The CleanCut® tool is available in standard, quarter round, profiler, or parallel sharpening style.

Pricing: Page 1/Rows L-O

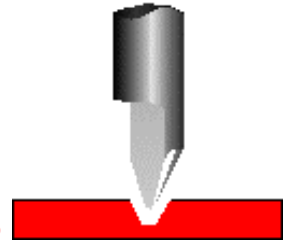

Diamond Gravers

Non-rotating tools with a diamond tip intended for scratch engraving on trophy brass and aluminum. Standard diamond has a 120° tip, other angles are available.

Special 90° diamonds for marking epoxy coated pens are also available.

Relapping service is available.

Pricing: Page 2/Row A

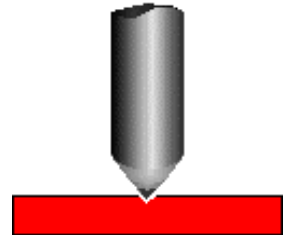

Rotating Diamonds

For glass engraving and burnishing. Particularly effective on colored aluminum. Standard tip sizes range from .005" to .030" in .005" increments. Larger tip sizes are available. *Call for a quote.*

Special rotating diamond for use on epoxy coated pens is also available. Creates a wider, cleaner cut than a diamond graver for an enhanced appearance.

Relapping service is available.

Pricing: Page 2/Row B

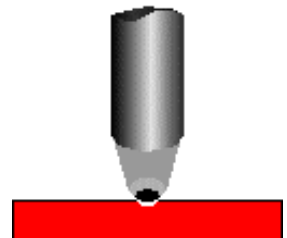

High Speed Steel Cutters

Engraving cutters manufactured from high speed steel. These tools are not as durable as carbide cutters, but are effective in applications requiring greater tip resiliency such as deep, fine cuts in metal.

We also offer a HSS cutter with narrower angles and a .010" tip specifically for engraving zinc seal dies. Specify "SLS" when ordering seal die cutters.

Pricing: Page 1/Row V

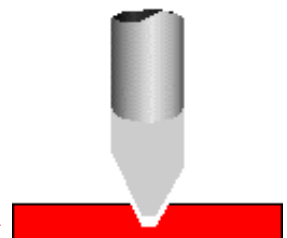

Special Length & Metric Tools: The following special length and metric tools are available to accommodate a variety of special spindle sizes and lengths as well as burnishing attachments and chip removers. Specify tip size and material classifications when ordering. *(See Price Sheet - Page 1)*

AC-127 - 1/8" x 5" or 6" Solid Micrograin Carbide for Burnishing Attachments or Chip Removers

AC-174 - 11/64" x 4-1/2" or 5" Solid Micrograin Carbide for 4" Spindles

AC-177 - 11/64" x 7" Micrograin Carbide Tipped for Burnishing Attachments or Chip Removers

AC-254 - 1/4" x 4 1/2" or 5" Solid Micrograin Carbide for 4" Spindles

AC-257 - 1/4" x 7" Micrograin Carbide Tipped for Burnishing Attachments or Chip Removers

AC-156 - 4mm x 114mm Solid Micrograin Carbide for Scripta S Models

AC-157 - 4mm x 165mm Micrograin Carbide Tipped for Burnishing Attachments or Chip Removers

AC-236 - 6mm x 165mm Micrograin Carbide Tipped for Scripta G Models

Prices listed on price sheet are for Standard conical cutters. All of the special length and metric tools are available in most sharpening styles for an additional charge. See pages 2-4 for sharpening styles.

SpiralFlute® Cutters

Antares SpiralFlute® Cutters are a hybrid between an engraving cutter and a RouterMill®. They provide the same cutting characteristics as a standard engraving cutter while benefitting from the strength of a fluted tool. This extra strength produces a tool that performs exceptionally well in harder materials such as stainless steel. SpiralFlute® Cutters are available on most shank sizes and in tip sizes ranging from .005" to .060". These tools produce the best results with relatively slow spindle speeds (around 8,000 to 9,000 rpm), slow feed rates, and cutting fluid. SpiralFlute® Cutters are manufactured from a special grade of carbide that has a metallurgical structure even finer than our micrograin carbide. This carbide provides the best edge retention and sharpest cutting edges, while greatly reducing chipping.



Pricing: Page 3/Section A

RouterMills®

Antares RouterMills® have been designed using modified end mill and router bit technology. The results are tools that produce fast, clean, straight-walled cuts in a variety of materials at the higher speeds and lower torque typically associated with engraving machine spindles. These tools are available with one, two, or three flutes depending on the material being cut and the size of the tool. RouterMills® are available in 1/8" x 4-1/2", 11/64" x 6-1/2", and 1/4" x 6-1/2" sizes as well as metric and collet sizing to fit almost any engraving machine spindle. Most tools are available in several tip sizes ranging from .060" to the full width of the shank. RouterMills® are much stronger than Parallel Cutters and work exceptionally well for cutting out complex shapes and other applications where Parallel Cutters have traditionally been used.

Single Flute: For acrylic, Unisub®, ColorLine®, phenolic, and soft plastics.

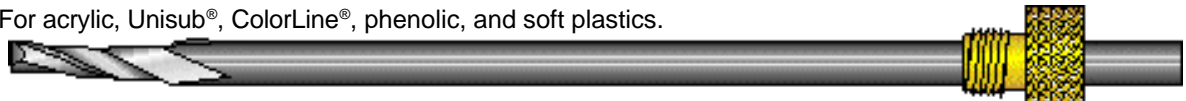

Two Flute: For brass, aluminum, bronze, copper, and other soft metals.



Three Flute: For steel, stainless steel and harder metals.



Pricing: Page 3/Section B

Ballnose RouterMill®

RouterMills® are also available as a ballnose tool. The radiused tip is ideal for creating smooth finishes on 3-D applications. Ballnose RouterMills® are available in tip sizes from one half of the shank diameter to the full width of the shank. These tools are available only as two flute tools, but have been proven effective in softer materials such as butter-board and soft plastics as well as harder materials such as acrylic and brass. RouterMills® are available in limited tip sizes on most shank sizes.



Pricing: Page 3/Section C

Replaceable Tip RouterMills®

The Replaceable Tip RouterMills® consist of a steel shank and a replaceable micrograin carbide insert. Thus it has the same cutting characteristics as our standard RouterMills®, but with a reduced cost. When an insert wears or breaks, it can be replaced. These tools are ideal for cutting out shapes and should be used instead of a Parallel Cutter. Inserts are available in .060", .090", and .125" tips and as drill points. Replaceable Tip RouterMills® are available as 1 FLUTE tools only and are designed for use in PLASTICS ONLY.



Pricing: Page 3/Section D

Special Cutters:

3-D Cutters - A tool with a long, narrow angle used for deep, reverse cuts in acrylic, producing an eye-catching, three-dimensional effect. *An Antares Fact Sheet is available on our web page: www.antareshinc.net.*

Pricing: Page 1/Row P

Rubber Stamp Cutters - A cutter used for engraving rubber stamp matrix material. A narrow profile prevents the edges of letters from running together and the center of letters from being cut out. For the best results, use a single line font with a minimum character height of 3/32". Pricing: Page 1/Row Q

Stencil Cutters / Cutters with Face Relief - Cutters with additional face relief specifically for cutting soft material, mylar, and stencils. Pricing: Page 1/Row R

Seal Cutters - High speed steel cutters sharpened specifically for cutting zinc seal dies. Standard tip size is .010". Pricing: Page 2/Table I Carbide cutters sharpened specifically for cutting brass seal dies also available.

Unsharpened Cutters - The same tool blanks we produce for our sharpened cutters. Available as split half round blanks or quarter round blanks. Pricing: Page 1/Rows S & T

Pyramid Cutter - Rotating carbide cutter specifically for epoxy coated pens. The pyramid design helps eliminate tip breakage. Not for chrome, steel, gold, etc. For best results, use a single line extended font with a character height of approximately 1/16". Pricing: Page 1/Row U

Cutters for Scott® & Kantograph® - 1/8" x 1" engraving tools. Carbide tools for plastics. High speed steel tools for metals. Burnishers for trophy brass. Diamonds for diamond drag (non-rotating). Pricing: Page 2 Table G

Cutters for Mimaki® - Cutters with a flat for a set screw. 6mm x 28mm or 1/4" x 1.10". Specify material type and tip width (.000" to full shank width). Pricing: Page 2/Table H

Custom Cutters - Antares can also make custom tools for specific applications.

Vinyl Cutting Blades - Blades for most of the popular plotters including Anagraph®, GCC®, Gerber®, Graphtec®, Ioline®, Mimaki®, Mutoh®, and Summagraphics®. *Call for a catalog.*

Taper Shank Cutters, Collet Cutters, and Industrial Tool Blanks are available in our Collet/Industrial Catalog. *Call for a catalog.*

Accessories:

Cutter Wrenches - Antares Standard Wrench

Cutting Fluids - A-9® (for Aluminum), Option 1®, Rapid Tap®

Burnishing Attachment - EZ-Rider® spring-loaded burnishing attachment. Light, constant downward pressure while burnishing compensates for irregularities in material. A Fact Sheet on Burnishing is available.

Optical Comparator - 7x Optical Comparator with .005" scale for measuring tip sizes.

Cutter Organizer - Keeps up to 24 cutters organized and well-protected. Comes with handy tip-sizing chart for easy reference. Specify for 1/8" cutters or for 11/64" and 1/4" cutters.

Diamond Wheels - 2 1/4" diameter to fit New Hermes® Grinders. Specify medium (320 grit) or fine (600 grit). Antares also offers Diamond Wheels for other popular grinders including Preis®, Decke®, Kuhlmann®, Alexander®, Gorton®, and others.

Pricing: Page 2/Table D

EZ-Rider® Burnishing Attachment

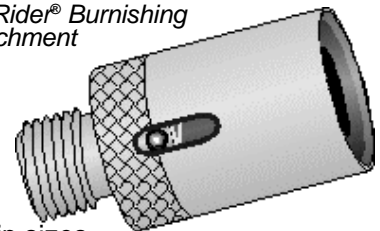

Resharpener: *We sharpen your own cutters - they are not exchanged.*

Antares sharpening is done using the same techniques and exacting specifications used in the manufacturing of new cutters. Each cutter is ground to remove any imperfections, the cutting edge is restored and the tip accurately sized. Cutter shanks are cleaned and oiled as required and damaged or stripped set screws are replaced at no additional charge. Unless otherwise specified, cutters will be sharpened to the size and for the material indicated on the knob. If the knob has no marking, please specify the application and desired size. See bottom of the price sheet for sharpening prices. *All cutter types and shank sizes can be combined for quantity pricing.* Pricing: Page 1/Table X

Shear Resharpener & Service: We offer sharpening and realignment services for standard 12" shears. *An Antares Fact Sheet on shear alignment is available free of charge.* Pricing: Page 1/Table X

For almost half a century, Antares has been dedicated to producing quality cutting tools specifically for the engraving and sign industries. We manufacture a large selection of standard tools and specialty cutters, in a wide variety of sizes, for the most popular manual and computer operated machines. By designing and manufacturing our own cutting tools, we maintain complete control over quality by enforcing the most exacting tolerances and specifications. Only Antares cutters come with our MicroEdge® finish to provide cleaner cuts and longer tool life. Our unique grinding techniques yield superior finishes and produces the finest, sharpest cutting edge available on any engraving cutter.

Antares has also been a leader in providing technical knowledge and support to the industry. We research and publish industry fact sheets as well as maintain a toll-free technical support service. In an effort to provide the most comprehensive and useful customer service, Antares has created a web page dedicated to providing technical information, assistance, and distributor information. Antares products are available from 85 distributors in 35 countries. Visit us at www.antaresinc.net to find your nearest distributor, or the answer to any technical question.

Let Antares help make your products attractive and eye-catching. We are dedicated to providing you with the highest quality cutting tools, friendly service, extensive technical knowledge, quick turn around times, and competitive pricing. Call us today at (800) 355-5250.

<http://www.antaresinc.net>

Antares, Inc. is proud to host and maintain one of the most extensive and comprehensive websites devoted to cutting tools and engraving.

- Engraving Fact Sheets have been posted on-line for engravers to read and download. Topics range from basic rotary engraving to shear maintenance and realignment.
- Frequently Asked Questions section contains answers to common questions and problems experienced by engravers.
- Online catalogs give customers up to date product listings and descriptions.
- What's New section provides the most current information on new tool development and production.

Terms & Conditions

Warranty

Antares, Inc. warrants its products to be free of defect in materials and workmanship, and will guarantee conformance to physical specifications. Due to the variety of applications and conditions involved, we can not guarantee tool performance. We stand behind what we sell and will repair or replace defective products which have not been damaged through misuse, unauthorized modification or repair. Antares, Inc. will not be held liable for any injury, loss, or damage, direct or consequential, arising from the use of its products.

Pricing

Antares, Inc. will make every possible effort to maintain the pricing in this catalog, however, prices are subject to change without notice. Minimum order is \$20.00.

Returns

There is a 15% re-stocking charge for the return of standard stock items. We are sorry, but custom made items are not returnable.

Changes

Antares, Inc. reserves the right to change, modify, discontinue, or terminate any product described in this catalog without notice.

418-2 Caredean Drive
Horsham, PA 19044
U.S.A.

**Antares, Inc.**
Web Page: www.antaresinc.net
E-mail: antares@antaresinc.net

Phone: (800) 355-5250
(215) 441-5250
Fax: (800) 355-0154
(215) 441-0154